

DOMX[®]

The Revolution in HRSA Turning



PalbitUSA.com



DOMX

NEW

PHH

NEW
GRADE

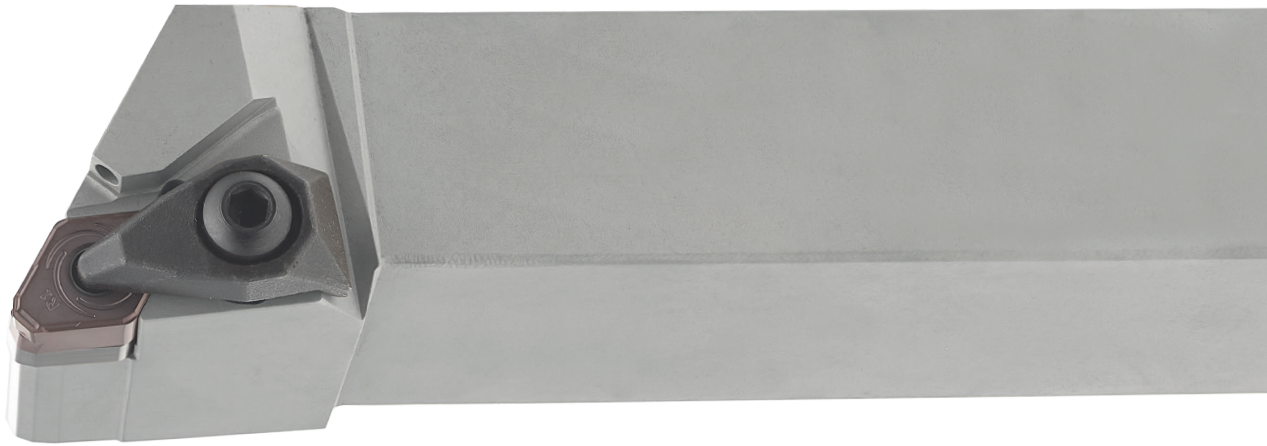

DOMX[®]

SINCE 1916

Designed especially for HRSA, the new DOMX[®] combined with the latest PHH technology offers exceptional performance in exotic materials machining. When your material has high Ni or Co content, DOMX[®] is the choice!

- 🔗 First choice for **HRSA** medium to rough turning
- 🔗 **4 positive cutting edges on double sided negative insert**

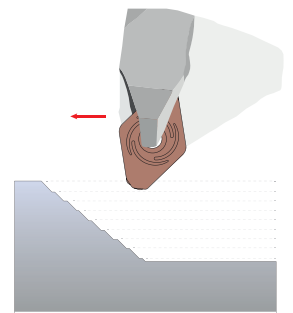

- 🔗 Machine at 45° with a 93° holder
- 🔗 **Up to +140% tool life improvement**

PHH GRADE

As a product of the latest coating technology, PHH coating revolutionizes the turning of HRSA materials. PHH is a stable PVD coating that combines high hardness with unmatched heat resistance.



First choice for HRSA.

Solution for general turning of HRSA.



	1	5	10	15	20	25	30
S HEAT RESISTANT / TITANIUM ALLOYS			PHH910	PHH910	PHH910	PHH910	PHH910
				PHH920	PHH920	PHH920	PHH920
							PVD

Inserts	(1) Geometry Code	ISO Reference	S		Dimensions (mm)					Cutting Conditions					Technical Drawing
			PVD		D	S	Re	d1	ap (mm)	Min	Max	fn (mm/rev)	Min	Max	
			(2) Grade Code	X6											
DOMX-GS	1124595	DOMX 1506R1-GS	PHH910	PHH920	12.70	6.35	0.80	5.16	1.50	0.20	2.00	0.30	0.20	0.50	
DOMX-GS	1124493	DOMX 1506L1-GS	PHH910	PHH920	12.70	6.35	0.80	5.16	1.50	0.20	2.00	0.30	0.20	0.50	

First choice
 Stock Items
 Available upon request
 Insert Order Code: (1) Geometry code + (2) Grade code

A = DDJN-DX1 45° || TOOLHOLDERS

(D) DIMPLE LOCK TOOLHOLDERS

Roughing to Heavy Roughing	Roughing to Heavy Roughing
DOMX (L1)	DOMX (R1)
(15)	(15)

Order Code		Reference	Dimensions (in)					Insert	lbs	Stock	
R	L		H=h	b	L1	L2	S			R	L
182020400	182020700	DDJN R/L 124 BAN-DX1	0.750	0.750	4.500	1.535	1.000	DOMX 1506..	0.88	<input checked="" type="checkbox"/>	<input checked="" type="checkbox"/>
182020500	182020800	DDJN R/L 164 DAN-DX1	1.000	1.000	6.000	1.535	1.250	DOMX 1506..	1.54	<input checked="" type="checkbox"/>	<input checked="" type="checkbox"/>
182020600	182020900	DDJN R/L 204 DAN-DX1	1.250	1.250	6.000	1.535	1.500	DOMX 1506..	2.76	<input checked="" type="checkbox"/>	<input checked="" type="checkbox"/>

Stock item
 Available upon request

Order Code		Reference	Dimensions (mm)					Insert	Kg	Stock	
R	L		H=h	b	L1	L2	S			R	L
182000900	182001200	DDJN R/L 2020 K15-A-DX1	20	20	125	42	25	DOMX 1506..	0.40	<input checked="" type="checkbox"/>	<input checked="" type="checkbox"/>
182001000	182001300	DDJN R/L 2525 M15-A-DX1	25	25	150	42	32	DOMX 1506..	0.75	<input checked="" type="checkbox"/>	<input checked="" type="checkbox"/>
182001100	182001400	DDJN R/L 3232 P15-A-DX1	32	32	170	42	40	DOMX 1506..	1.30	<input checked="" type="checkbox"/>	<input checked="" type="checkbox"/>

Stock item
 Available upon request



SPARE PARTS

Cutter Reference	Shim R	Shim L	Shim Screw	Spring	Clamp	Clamp Screw	Wrench	Coolant Screw 1	Coolant Screw 2	Coolant Screw 3
DDJN R/L 2020 K15-A-DX1	CD150503	CD150502	T06010000	M09513	GA07002	D0602900	SS40	H0600475	H1000875	T1000875
DDJN R/L 2525 M15-A-DX1	CD150503	CD150502	T06010000	M09513	GA07002	D0602900	SS40	H0600475	H1000875	T1000875
DDJN R/L 3232 P15-A-DX1	CD150503	CD150502	T06010000	M09513	GA07002	D0602900	SS40	-	H1000875	-







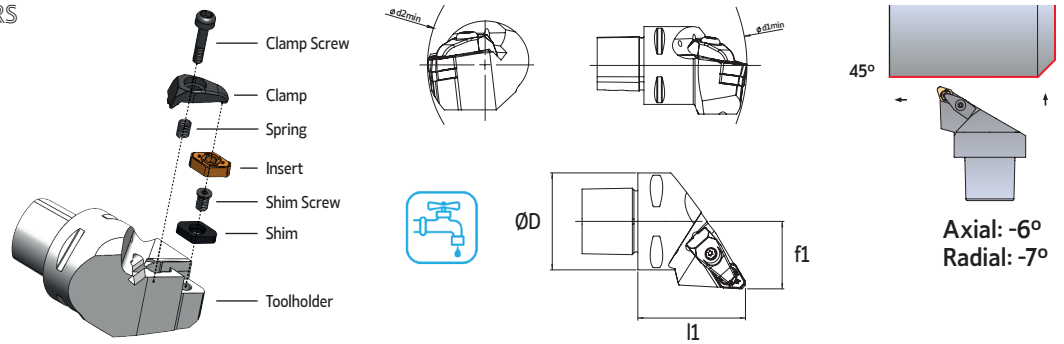

A = DDJN-DX1 45° || TOOLHOLDERS

NEW

(D) DIMPLE LOCK TOOLHOLDERS

Roughing to Heavy Roughing	Roughing to Heavy Roughing
DOMX (L1)	DOMX (R1)
	
(15)	(15)









Order Code		Reference	Dimensions (mm)					Insert	Kg	Stock	
R	L		ØD	Ød1 min	Ød2 min	f1	l1			R	L
182000100	182000500	PSC40-DDJNR/L27055-15-DX1	40	110	145	27	55	DOMX 1506..	0,42		
182000200	182000600	PSC50-DDJNR/L35060-15-DX1	50	110	165	35	60	DOMX 1506..	0,80		
182000300	182000700	PSC63-DDJNR/L45065-15-DX1	63	110	190	45	65	DOMX 1506..	1,10		
182000400	182000800	PSC80-DDJNR/L55080-15-DX1	80	110	250	55	80	DOMX 1506..	2,74		

 Stock item

 Available upon request

SPARE PARTS

Cutter Reference	Shim R	Shim L	Shim Screw	Spring	Clamp	Clamp Screw	Wrench
PSC40-DDJNR/L27055-15-DX1							
PSC50-DDJNR/L35060-15-DX1	CD150503	CD150502	T06010000	M09513	GA07002	D0602900	SS40
PSC63-DDJNR/L45065-15-DX1	CD150503	CD150502	T06010000	M09513	GA07002	D0602900	SS40
PSC80-DDJNR/L55080-15-DX1	CD150503	CD150502	T06010000	M09513	GA07002	D0602900	SS40

Note: It is possible to adapt your standard toolholder

U.S. Partner:



Precision Products

15 Merrigan Way | South Deerfield, MA 01373

413-350-5200 | PilotPrecision.com

ISO 9001:2015

